

general design information

# ABUS Overhead cranes

**ABUS**  
CRANE SYSTEMS

# Made in Gummersbach, Germany

**ABUS**  
Kransysteme GmbH,  
Gummersbach Works



**Experience crane technology in the KranHaus**

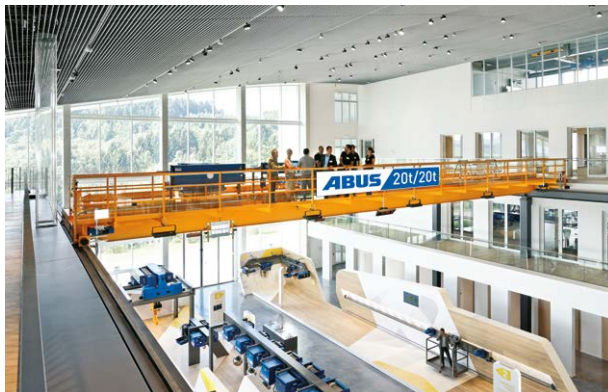

**View into the production plant**



The success of ABUS is based on consistent standardization of the product range with the aim of series production. Customer-oriented marketing and ABUS development work ensure that the standard range is continuously developed to reflect market requirements.

- 1964: Production of the first jib crane. Shortly afterwards, first major order (for 27 jib cranes)
- 1965: Construction of Lantenbach production plant near Gummersbach; ABUS has a staff of 20
- 1973/74: ABUS draws conclusions from the world-wide recession: expansion of series production for increased cost-effectiveness
- 1982: ABUS has a staff of 110
- 1984: The year of innovations – HB system – ABUS electric wire rope hoist – ABUS electric chain hoist
- 1987: Expansion. Construction of a second production plant at Marienheide, near Gummersbach.
- 1989: Construction of advanced factory at Rodt, near Gummersbach

- 1991/92: ABUS has a staff of 550
- 1992/93: Systematic expansion of exports. ABUS Representative Office established in Singapore. Another consultant develops the Middle East market.
- 1993: World-wide recession: ABUS remains successful thanks to flexible extension of the standard range and expansion of the sales network: 20 representatives in Germany, about 40 sales partners world-wide.
- 1994: ELS: Single girder crane with side running trolley (Type S)  
ABUS products with CE sign  
Modular drive unit AZF 400
- 1995: ABUS Push button pendant  
Modular drive unit AZF 500
- 1996: Standard operating hours meter on electric wire rope hoists  
Load measuring system LIS-AV  
Overload protection device LIS-SM
- 1997: Construction of new production plant "Lantenbach Nord" (11.000 m<sup>2</sup>)  
Modular travel drive HBF  
ABUS subsidiary in Shanghai (China)
- 1998: New painting system (Single-coat paintwork)  
Load measuring system "ABUControl"  
Mobile gantry LPK  
Electric chain hoist "ABUCompact GMC"  
Power supply via energy chain system
- 1999: Load indicator system LIS-SE; Profile HB100
- 2000: ABUS radio remote control system Pocket
- 2001: ABUS radio remote control system Mini-RC
- 2002: Electric chain hoist "ABUCompact GM 2"  
The electric wire rope hoist range has been extended up to 100 t SWL
- 2003-05: Electric chain hoists "ABUCompact GM8, GM4, GM6"
- 2006/07: New end carriages  
Completed construction and moved into the new Customer Information Centre
- 2008: Stooled up single-girder crane EHB-X and stooled up double-girder crane ZHB-X  
End carriage AZF 350
- 2009: Single-girder crane EHB-I and double-girder crane ZHB-I  
Monorail wire rope hoist type E up to a maximum SWL of 16 t  
Establishment of a new apprenticeship workshop for engineering apprentices
- 2010: Wire rope crab unit type Z up to a maximum SWL of 120 t  
Completion of a new production facility at "Herreshagen"
- 2011: ABUS radio remote control system ABURemote
- 2012: Single-girder semi-goliath crane EHPK
- 2014: Revision of the light crane system
- 2015: Launch of the intelligent crane control 'ABUControl' and the modular wire rope hoist generation
- 2016: Commissioning of the exhibition and seminar center KranHaus and the associated administrative building



# ABUS system expertise: Individual materials handling from one source



ABUS crane systems and components:



Travelling Cranes



Jib Cranes



HB-System



LPK mobile gantry



Electric Wire Rope Hoists



Electric Chain Hoists

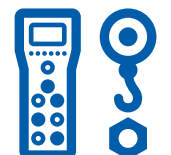

High-performance Components



ABUS offers you overhead lifting and materials handling technology from 80 kg up to 120 t from one source – from the stationary electric chain hoist to jib cranes, lightweight overhead systems, electric wire rope hoists, travelling cranes and including complete materials handling systems. All ABUS crane systems, hoists and components can be used as stand-alone units but they are also designed for smooth interaction with each other, from easy plug-in connections through to maintenance and spare part stocks.

A customer who chooses ABUS systems can rely on ABUS absolutely.





**General remarks on design**

<b>Design basis</b>	DIN 15018, H2/B3 indoor operation, without crane walkway without driver's cabin operating voltage 400 V / 50 Hz				
<b>Crane travelling speed</b>	EDL	: 7.5/30 m/min			
	ELV / ELK / ZLK	: 10/40 m/min			
<b>Trolley travelling speed</b>	ELV / ELK / EDL / ZLK	: 5/20 m/min			
	Standard – other speeds are available				
<b>Deflection</b>	<= 1/750 of span				
<b>Natural frequencies</b>	ELV / EDL	: >= 2.5 Hz			
	ELK / ZLK	: see below			
	S [m] <=	23.0	25.0	28.0	32.0
	FE [Hz] >=	2.5	2.4	2.3	2.2

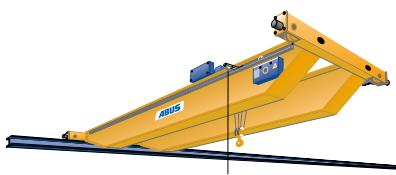

## ZLK Double Girder Cranes

The measurements A1, C1 and K1 can be changed by adjusting to existing build conditions, by pushing up the bottom of the main girder up to the bottom of the end carriage.

For exact measurements please contact ABUS

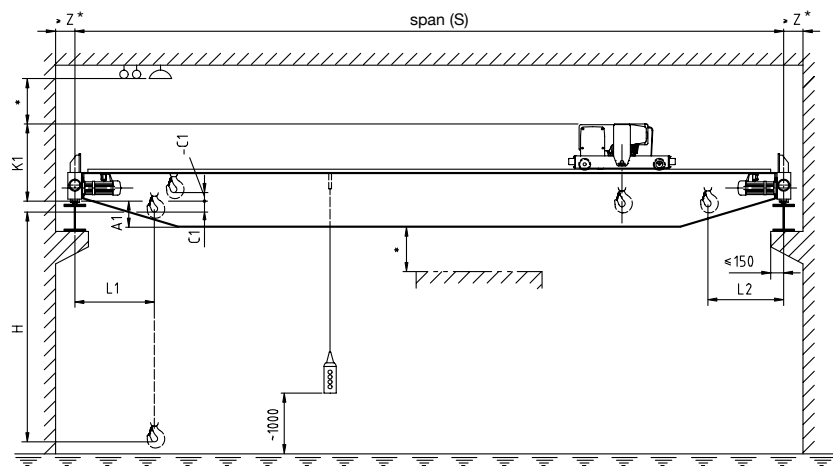

\* Safety distance according to national regulations.

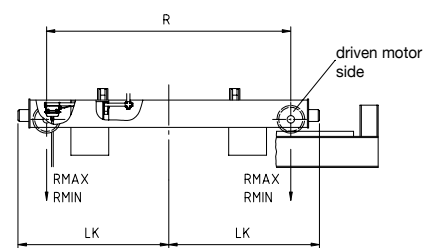
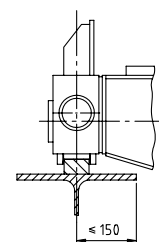

# Dimensions of ZLK Double Girder Cranes<sup>1)</sup>

Load	S <sup>2)</sup>	A3	K1	C1	L1	L2	Z min	H max <sup>2)</sup>	R	LK	Wheel loads KN		
Hoist type <sup>1)</sup>	m	mm	mm	mm	mm	mm	mm	mm	mm	mm	R max R min		
5000 kg Rope hoist GM 1050 H6 FEM 2m	10	200	770	-50	660	660	150	9000	2700	1605	30.6	6.9	
	14	300	770	-50	660	660	150	9000	2700	1605	33.5	8.7	
	16	300	770	-50	660	660	150	9000	2700	1630	35.5	10.4	
	18	400	770	-50	660	660	150	9000	2700	1630	37.5	12.1	
	20	500	770	-50	660	660	150	9000	2900	1730	39.6	14.0	
	22	460	810	-90	660	660	170	9000	3200	1895	42.7	17.0	
	24	560	810	-90	660	660	170	9000	3800	2230	45.7	19.7	
	26	500	870	-150	660	660	180	9000	4600	2650	50.7	24.4	
	28	700	870	-150	660	660	180	9000	4600	2650	53.2	26.8	
	30	700	870	-150	660	660	180	9000	4600	2650	57.2	30.7	
	32	650	920	-200	660	660	180	9000	5100	2965	66.3	39.5	
	34	660	920	-200	660	660	180	9000	5100	2965	71.7	44.9	
	6300 kg Rope hoist GM 2063 H6 FEM 1Am	10	200	770	-30	660	660	150	9000	2700	1605	36.9	7.4
		14	300	770	-30	660	660	150	9000	2700	1630	40.5	9.7
16		400	770	-30	660	660	150	9000	2900	1730	42.6	11.4	
18		500	770	-30	660	660	150	9000	2900	1730	44.7	13.3	
20		500	770	-30	660	660	150	9000	2900	1730	46.0	14.3	
22		560	810	-70	660	660	170	9000	3200	1895	49.0	17.0	
24		500	870	-130	660	660	180	9000	3800	2250	55.0	22.7	
26		500	870	-130	660	660	180	9000	3800	2250	58.7	26.3	
28		700	870	-130	660	660	180	9000	4600	2650	61.9	29.3	
30		700	870	-130	660	660	180	9000	4600	2650	66.1	33.3	
32		660	920	-180	660	660	180	9000	5100	2965	76.0	42.9	
34		900	920	-180	660	660	180	9000	5100	2965	78.7	45.6	
8000 kg Rope hoist GM 3080 H6 FEM 3m		10	300	860	10	760	760	150	10000	2700	1605	45.7	9.0
		14	400	860	10	760	760	150	10000	2700	1630	49.7	11.1
	16	460	900	-30	760	760	170	10000	2900	1745	52.4	13.1	
	18	460	900	-30	760	760	170	10000	2900	1745	53.9	14.2	
	20	460	900	-30	760	760	170	10000	2900	1745	56.6	16.4	
	22	560	900	-30	760	760	170	10000	3200	1930	59.3	18.9	
	24	500	960	-90	760	760	180	10000	3800	2250	65.8	25.0	
	26	700	960	-90	760	760	180	10000	3800	2250	68.5	27.5	
	28	700	960	-90	760	760	180	10000	4600	2650	71.0	29.6	
	30	650	1010	-140	760	760	180	10000	4600	2715	79.2	37.7	
	32	900	1010	-140	760	760	180	10000	5100	2965	85.6	43.7	
	34	900	1010	-140	760	760	180	10000	5100	2965	87.9	45.9	
	10 000 kg Rope hoist GM 3100 H6 FEM 2m	10	260	900	-30	760	760	170	10000	2700	1620	55.6	10.5
		14	360	900	-30	760	760	170	10000	2700	1645	60.0	12.5
16		460	900	-30	760	760	170	10000	2900	1745	62.8	14.6	
18		460	900	-30	760	760	170	10000	2900	1745	64.5	15.7	
20		500	960	-90	760	760	180	10000	2900	1765	67.8	18.6	
22		500	960	-90	760	760	180	10000	3200	1950	71.0	21.4	
24		700	960	-90	760	760	180	10000	3800	2250	76.0	26.0	
26		700	960	-90	760	760	180	10000	3800	2250	78.0	27.8	
28		700	960	-90	760	760	180	10000	4600	2650	82.7	32.1	
30		660	1010	-140	760	760	180	10000	4600	2715	91.7	40.8	
32		900	1010	-140	760	760	180	10000	5100	2965	95.1	43.9	
34		900	1010	-140	760	760	180	10000	5100	2965	101.0	49.2	
12 500 kg Rope hoist GM 5125 L6 FEM 2m		10	300	1090	40	790	790	180	10000	2700	1665	70.4	13.2
		14	400	1090	40	790	790	180	10000	2900	1765	75.8	15.5
	16	400	1090	40	790	790	180	10000	2900	1765	78.6	17.2	
	18	500	1090	40	790	790	180	10000	2900	1765	81.4	19.4	
	20	500	1090	40	790	790	180	10000	2900	1765	83.3	20.7	
	22	700	1090	40	790	790	180	10000	3200	1950	86.4	23.2	
	24	650	1140	-10	790	790	180	10000	3800	2315	91.8	28.0	
	26	650	1140	-10	790	790	180	10000	3800	2315	95.9	31.7	
	28	900	1140	-10	790	790	180	10000	4200	2515	103.0	37.4	
	30	900	1140	-10	790	790	180	10000	4600	2715	107.0	42.0	
	32	900	1140	-10	790	790	180	10000	5100	3005	114.0	47.6	
	34	1150	1140	-10	790	790	180	10000	5100	3005	119.0	53.1	
	16 000 kg Rope hoist GM 5160 H6 FEM 1Am	10	300	1090	40	790	790	180	10000	2700	1665	87.1	15.4
		14	350	1140	-10	790	790	180	10000	2900	1830	94.7	19.1
16		450	1140	-10	790	790	180	10000	2900	1830	97.9	21.1	
18		460	1140	-10	790	790	180	10000	2900	1865	102.0	23.4	
20		650	1140	-10	790	790	180	10000	3200	2015	105.0	26.6	
22		650	1140	-10	790	790	180	10000	3200	2015	108.0	28.3	
24		650	1140	-10	790	790	180	10000	3800	2315	113.0	32.3	
26		900	1140	-10	790	790	180	10000	3800	2315	116.0	35.5	
28		900	1140	-10	790	790	180	10000	4200	2515	119.0	37.9	
30		900	1140	-10	790	790	180	10000	4600	2755	127.0	45.2	
32		910	1140	-10	790	790	180	10000	5100	3005	133.0	51.0	
34		1100	1190	-60	790	790	190	10000	5100	3055	141.0	58.2	

Load	S <sup>2)</sup>	A3	K1	C1	L1	L2	Z min	H max <sup>2)</sup>	R	LK	Wheel loads KN		
Hoist type <sup>1)</sup>	m	mm	mm	mm	mm	mm	mm	mm	mm	mm	R max R min		
20 000 kg Rope hoist GM 6200 L6 FEM 2m	10	250	1330	-130	820	820	180	10000	2900	1830	109.0	19.7	
	14	360	1330	-130	820	820	180	10000	2900	1830	116.0	21.8	
	16	460	1330	-130	820	820	180	10000	2900	1865	119.0	23.8	
	18	650	1330	-130	820	820	180	10000	2900	1865	123.0	26.1	
	20	650	1330	-130	820	820	180	10000	3200	2015	127.0	29.7	
	22	900	1330	-130	820	820	180	10000	3200	2015	131.0	32.6	
	24	900	1330	-130	820	820	180	10000	3800	2315	134.0	35.0	
	26	900	1330	-130	820	820	180	10000	3800	2315	139.0	39.0	
	28	860	1380	-180	820	820	190	10000	4100	2515	146.0	44.9	
	30	860	1380	-180	820	820	190	10000	4600	2805	152.0	51.0	
	32	1100	1380	-180	820	820	190	10000	5100	3055	159.0	56.8	
	34	1100	1380	-180	820	820	190	10000	5100	3055	162.0	59.7	
	25 000 kg Rope hoist GM 6250 L6 FEM 1Am	10	350	1330	-130	820	820	180	10000	2900	1830	132.0	22.4
		14	600	1380	-180	820	820	190	10000	3000	1930	142.0	26.3
16		600	1380	-180	820	820	190	10000	3200	2065	146.0	29.0	
18		610	1380	-180	820	820	190	10000	3200	2065	151.0	31.9	
20		850	1380	-180	820	820	190	10000	3200	2065	154.0	33.6	
22		850	1380	-180	820	820	190	10000	3200	2065	158.0	37.2	
24		860	1380	-180	820	820	190	10000	3800	2365	164.0	41.7	
26		860	1380	-180	820	820	190	10000	3800	2365	167.0	44.0	
28		860	1380	-180	820	820	190	10000	4600	2765	174.0	50.0	
30		860	1380	-180	820	820	190	10000	4600	2805	181.0	56.9	
32		1110	1380	-180	820	820	190	10000	5100	3055	190.0	64.4	
34		930	1560	-360	820	820	270	10000	5100	3055	201.0	75.1	
32 000 kg Rope hoist GM 7320 H6 FEM 2m		10	400	1460	40	1080	1080	190	8000	3400	2130	166.0	32.8
		14	600	1460	40	1080	1080	190	8000	3600	2265	179.0	34.7
	16	610	1460	40	1080	1080	190	8000	3600	2265	184.0	36.7	
	18	850	1460	40	1080	1080	190	8000	3600	2265	189.0	39.4	
	20	850	1460	40	1080	1080	190	8000	3600	2265	193.0	41.0	
	22	860	1460	40	1080	1080	190	8000	3600	2265	198.0	44.6	
	24	680	1640	-140	1080	1080	270	8000	3600	2305	207.0	51.7	
	26	920	1640	-140	1080	1080	270	8000	3800	2405	213.0	56.5	
	28	930	1640	-140	1080	1080	270	8000	4300	2655	220.0	62	

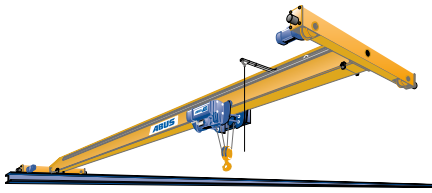

# ELV/ELK Single Girder Cranes

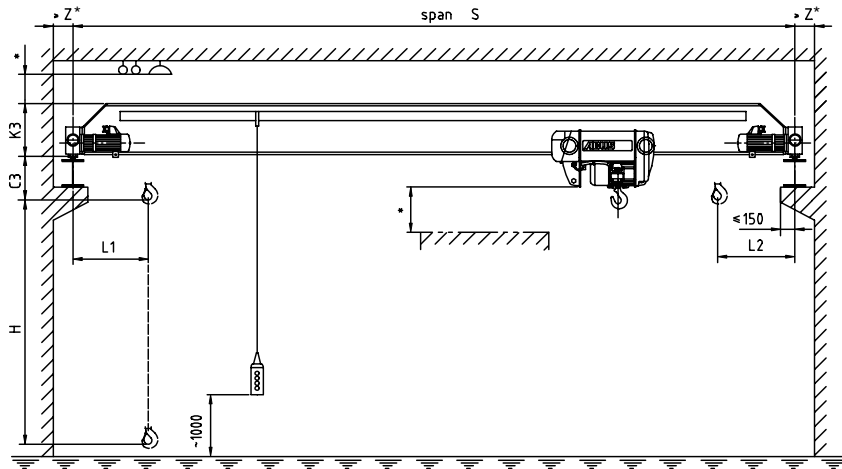

\* Safety distance according to national regulations.

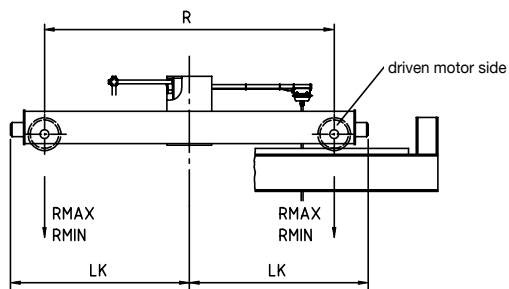

### Variation 3:

The measurements K3 and C3 are ABUS standard measurements and can be changed according to the chosen main girder connection variation

For exact measurements of the Variation 1, 2, 4, 5 please contact ABUS

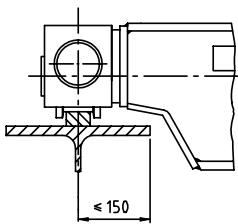

### Variation 1:

top of the main girder = top of the end carriage

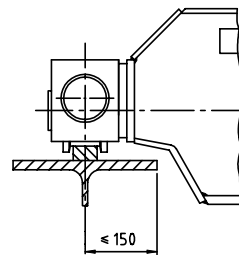

### Variation 2:

all varieties between variation 1 and 3

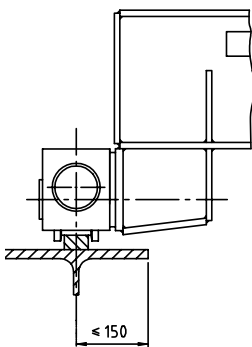

### Variation 4:

bottom of the main girder = top of the end carriage

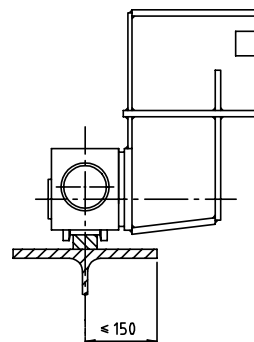

### Variation 5:

bottom of the main girder higher than the top of the end carriage but not more than 1500 mm between the top of the crane rail and the bottom of the main girder

# Dimensions of ELV/ELK Single Girder Cranes<sup>1)</sup>

Load	S <sup>2)</sup>	K3	C3	L1	L2	Z min	H max <sup>2)</sup>	R	LK	Wheel loads KN	
										R max	R min
Hoist type <sup>1)</sup>	m	mm	mm	mm	mm	mm	mm	mm	mm		
500 kg Chain hoist GM2 500 FEM 2m	5	290	480	540	440	140	8000	1900	1165	4.3	2.0
	10	290	480	540	440	140	8000	1900	1165	5.3	2.8
	15	330	480	540	440	140	8000	2200	1315	7.4	4.8
	18	410	480	540	440	140	8000	2700	1585	9.6	7.0
V Hoist = 1/4 m/min											
1000 kg Chain hoist GM4 1000 FEM 2m	5	290	520	560	450	140	6000	1900	1165	6.6	2.2
	10	290	520	560	450	140	6000	1900	1165	7.8	2.9
	15	330	520	560	450	140	6000	2200	1315	9.9	4.9
	18	410	520	560	450	140	6000	2700	1585	12.1	7.1
V Hoist = 1.3/5 m/min											
1600 kg Rope hoist GM 816 L6 FEM 4m	5	290	390	950	640	140	9000	1900	1165	9.8	3.0
	10	290	390	950	640	140	9000	1900	1165	11.4	3.4
	15	350	390	950	640	140	9000	2200	1315	13.7	5.4
	18	410	390	950	640	140	9000	2700	1610	15.7	7.2
V Hoist = 0.8/5 m/min											
2000 kg Rope hoist GM 820 L6 FEM 4m	5	290	390	950	640	140	9000	1900	1165	11.5	3.3
	10	330	390	950	640	140	9000	1900	1165	13.7	4.1
	15	370	390	950	640	140	9000	2200	1335	15.9	5.7
	18	550	380	970	770	150	9000	2700	1605	16.5	6.6
	20	650	380	970	770	150	9000	3200	1855	17.7	7.4
	22	660	380	970	770	150	9000	3200	1880	19.1	9.0
	24	760	380	970	770	170	9000	3800	2195	20.6	10.4
	26	760	430	970	770	170	9000	3800	2195	22.6	12.3
V Hoist = 0.8/5 m/min											
3200 kg Rope hoist GM 832 H6 FEM 2m	5	330	390	950	640	140	9000	1900	1165	16.9	4.3
	10	320	390	950	640	140	9000	1900	1165	19.7	4.9
	15	450	390	950	640	140	9000	2200	1335	22.5	7.0
	18	650	380	970	770	150	9000	2700	1605	23.1	7.6
	20	660	380	970	770	150	9000	3200	1880	24.3	8.9
	22	760	380	970	770	150	9000	3200	1880	25.6	9.8
	24	760	430	970	770	170	9000	3800	2195	28.4	12.5
	26	860	430	970	770	170	9000	3800	2195	29.6	13.7
V Hoist = 0.8/5 m/min											
5000 kg Rope hoist GM 1050 H6 FEM 2m	5	330	490	1030	710	140	9000	1900	1165	25.1	6.2
	10	410	490	1030	710	140	9000	1900	1185	29.3	6.6
	15	550	490	1030	710	140	9000	2200	1335	32.4	8.5
	18	660	480	1060	840	150	9000	2700	1605	33.3	9.3
	20	660	480	1060	840	150	9000	3200	1880	35.0	10.9
	22	760	480	1060	840	150	9000	3200	1880	36.5	12.1
	24	860	530	1060	840	170	9000	3800	2195	38.9	14.4
	26	1060	530	1060	840	170	9000	3800	2195	41.4	16.7
V Hoist = 0.8/5 m/min											

Load	S <sup>2)</sup>	K3	C3	L1	L2	Z min	H max <sup>2)</sup>	R	LK	Wheel loads KN	
										R max	R min
Hoist type <sup>1)</sup>	m	mm	mm	mm	mm	mm	mm	mm	mm		
6300 kg Rope hoist GM 2063 H6 FEM 1Am	5	350	490	1090	810	140	9000	1900	1165	30.5	8.0
	10	470	480	1090	810	150	9000	1900	1205	36.2	8.3
	15	660	480	1170	940	150	9000	2200	1355	37.9	8.7
	18	760	480	1170	940	150	9000	2700	1630	39.9	10.0
	20	760	480	1170	940	150	9000	3200	1880	42.0	11.8
	22	860	530	1170	940	170	9000	3200	1895	43.9	13.4
	24	1060	530	1170	940	170	9000	3800	2195	46.9	16.2
	26	1060	530	1170	940	170	9000	3800	2230	48.1	17.2
V Hoist = 0.8/5 m/min											
8000 kg Rope hoist GM 3080 H6 FEM 3m	5	550	560	1210	990	150	10000	1900	1205	37.1	11.3
	10	560	560	1210	990	150	10000	1900	1205	43.1	8.8
	15	660	560	1210	990	150	10000	2200	1380	47.6	10.5
	18	760	560	1210	990	170	10000	2700	1645	50.7	12.6
	20	760	610	1210	990	170	10000	3200	1895	53.1	14.6
	22	860	610	1210	990	170	10000	3200	1895	54.6	15.7
	24	1060	610	1210	990	180	10000	3800	2215	58.3	19.0
	26	1060	610	1210	990	180	10000	3800	2250	60.0	20.5
V Hoist = 0.8/5 m/min											
10 000 kg Rope hoist GM 3100 L6 FEM 2m	5	560	560	1210	990	150	10000	1900	1205	45.2	13.5
	10	560	560	1210	990	170	10000	1900	1220	52.8	10.6
	15	760	560	1210	990	170	10000	2200	1395	57.5	11.9
	18	860	610	1210	990	170	10000	2700	1645	60.8	14.0
	20	1060	610	1210	990	170	10000	3200	1895	63.4	16.1
	22	1060	610	1210	990	170	10000	3200	1895	64.8	17.0
	24	1060	610	1210	990	180	10000	3800	2215	69.9	21.6
	V Hoist = 0.66/4 m/min										

<sup>1)</sup> Safety distance according to national regulations. For exact measurements please contact ABUS

<sup>2)</sup> Larger span cranes, other hoist specifications are available

Note 1:  
The data apply to EOT cranes with power supply via energy chain system.





# EDL Single Girder Underslung Cranes

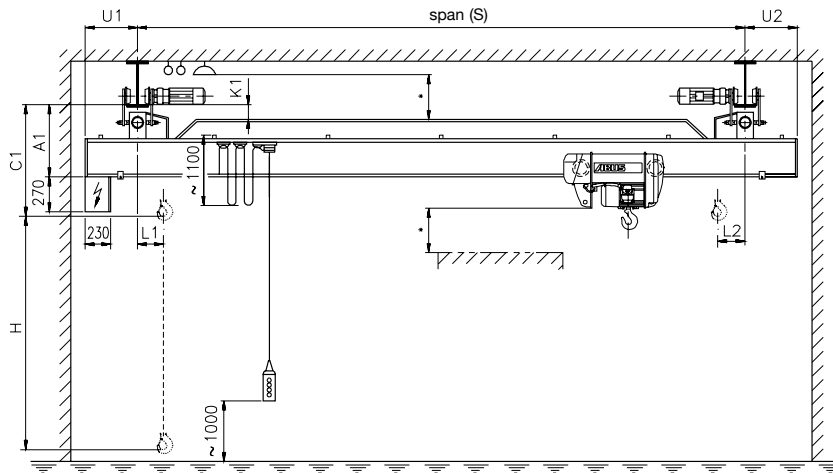

\* Safety distance according to national regulations.

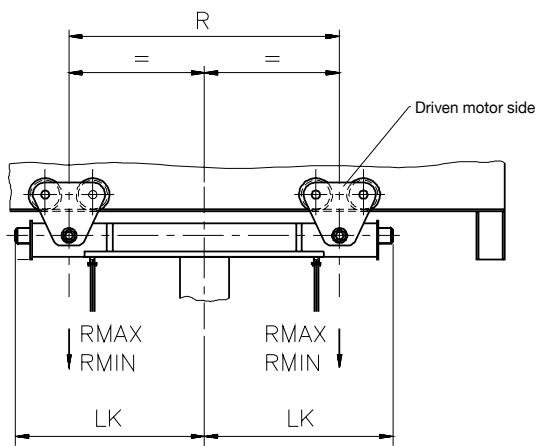

## Variation 1:

The measurements A1, C1 and K1 are ABUS standard measurements and can be decreased by choosing variation 2, K1 will then increase accordingly, U1/2 has to be cut off and L1 and L2 will increase also.

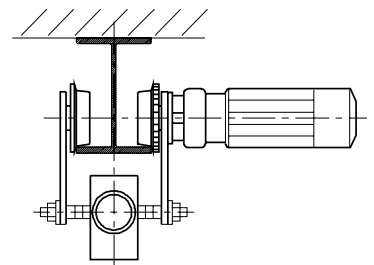
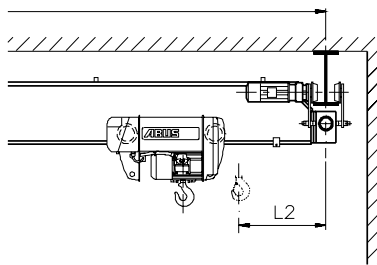

## Variation 2:

bottom of the main girder = bottom of the end carriage

For exact measurements of the Variation 2 please contact ABUS



# Dimensions of EDL Single Girder Underslung Cranes<sup>1)</sup>

Load	S <sup>2)</sup>	A1	C1	L1	L2	U1/2	H max <sup>2)</sup>	R	LK	K1	Wheel loads KN	
Hoist type <sup>1)</sup>	m	mm	mm	mm	mm	mm	mm	mm	mm	mm	R max	R min
500 kg Chain hoist GM2 500 FEM 2m V Hoist = 1/4 m/min	5	390	880	-20	-250	500	8000	1500	975	170	4.6	1.6
	10	430	910	-20	-250	500	8000	1500	975	170	5.4	2.5
	12	470	950	-20	-250	500	8000	2000	1225	170	6.3	3.5
	15	390	870	-270	-500	750	8000	2500	1475	60	8.3	5.3
1000 kg Chain hoist GM4 1000 FEM 2m V Hoist = 1.3/5 m/min	5	390	910	-10	-250	500	6000	1500	975	170	7.3	1.4
	10	440	950	-10	-250	500	6000	1500	975	170	8.6	3.0
	12	390	910	-10	-250	500	6000	2000	1225	100	9.2	3.7
	15	390	900	-260	-500	750	6000	2500	1475	60	10.9	5.3
1600 kg Rope hoist GM 816 L6 FEM 4m V Hoist = 0.8/5 m/min	5	470	860	390	-40	500	9000	1500	975	170	11.3	2.1
	10	510	900	390	-40	500	9000	1500	975	170	12.7	3.6
	12	510	900	390	-40	500	9000	2000	1225	170	13.2	4.2
	15	550	930	140	-290	750	9000	2500	1475	170	15.0	5.6
2000 kg Rope hoist GM 820 L6 FEM 4m V Hoist = 0.8/5 m/min	5	490	880	390	-40	500	9000	1500	975	170	13.4	2.2
	10	480	860	390	-40	500	9000	1500	975	170	14.8	3.7
	12	530	920	390	-40	500	9000	2000	1225	170	15.5	4.5
	15	470	850	140	-290	750	9000	2500	1475	100	17.3	5.8
	17	550	930	140	-290	750	9000	2500	1535	140	19.4	8.0

Load	S <sup>2)</sup>	A1	C1	L1	L2	U1/2	H max <sup>2)</sup>	R	LK	K1	Wheel loads KN	
Hoist type <sup>1)</sup>	m	mm	mm	mm	mm	mm	mm	mm	mm	mm	R max	R min
3200 kg Rope hoist GM 832 H6 FEM 2m V Hoist = 0.8/5 m/min	5	460	840	390	-40	500	9000	1500	975	170	19.4	2.3
	10	520	900	390	-40	500	9000	1500	975	170	21.4	4.4
	12	570	950	390	-40	500	9000	2000	1265	160	23.2	6.2
	15	570	950	140	-290	750	9000	2500	1535	110	25.4	7.8
5000 kg Rope hoist GM 1050 H6 FEM 2m V Hoist = 0.8/5 m/min	5	620	1100	480	30	500	9000	2000	1265	250	30.2	4.3
	10	560	1040	480	30	500	9000	2000	1285	140	32.7	6.6
	12	560	1040	480	30	500	9000	2000	1285	140	33.5	7.3
	15	570	1050	230	-220	750	9000	2500	1535	10	35.9	8.8
6300 kg Rope hoist GM 2063 H6 FEM 1Am V Hoist = 0.8/5 m/min	5	580	1060	580	130	500	9000	2000	1265	200	36.7	5.2
	10	570	1050	580	130	500	9000	2000	1285	10	39.6	7.3
	12	570	1050	580	130	500	9000	2000	1285	-40	40.9	8.4
	14	570	1050	580	130	500	9000	2000	1285	-40	41.9	9.3
8000 kg Rope hoist GM 3080 H6 FEM 3m V Hoist = 0.8/5 m/min	5	640	1200	620	180	500	10000	2000	1265	170	45.9	6.4
	8	630	1190	620	180	500	10000	2000	1285	20	47.9	7.2

<sup>1)</sup> Safety distance according to national regulations. For exact measurements please contact ABUS

<sup>2)</sup> Larger span cranes, other hoist specifications are available

Note:  
All data refers to cranes fitted with the festoon cable method of cross bridge power supply.



Special building characteristics often require a special crane design. ABUS overhead travelling cranes provide an optimal solution where the building structures make the normal travelling cranes less suitable. The main feature is that the crane track is not fastened to pillars but to the ceiling of the building. Over and above these special requirements the ABUS overhead travelling crane DLVM/EDL offers the advantage of very small trolley approach dimensions and as a result an optimal utilisation of the building width.

The whole production process is aimed at long-term quality. Here the rust is removed from robust main girder profiles of the EDL at the beginning of the production process using mechanical shot blasting.





**ABUS in operation:  
We would like to exceed your expectations**









